

Teken de spiegelbeelden.
De rechte s is de spiegelglas.

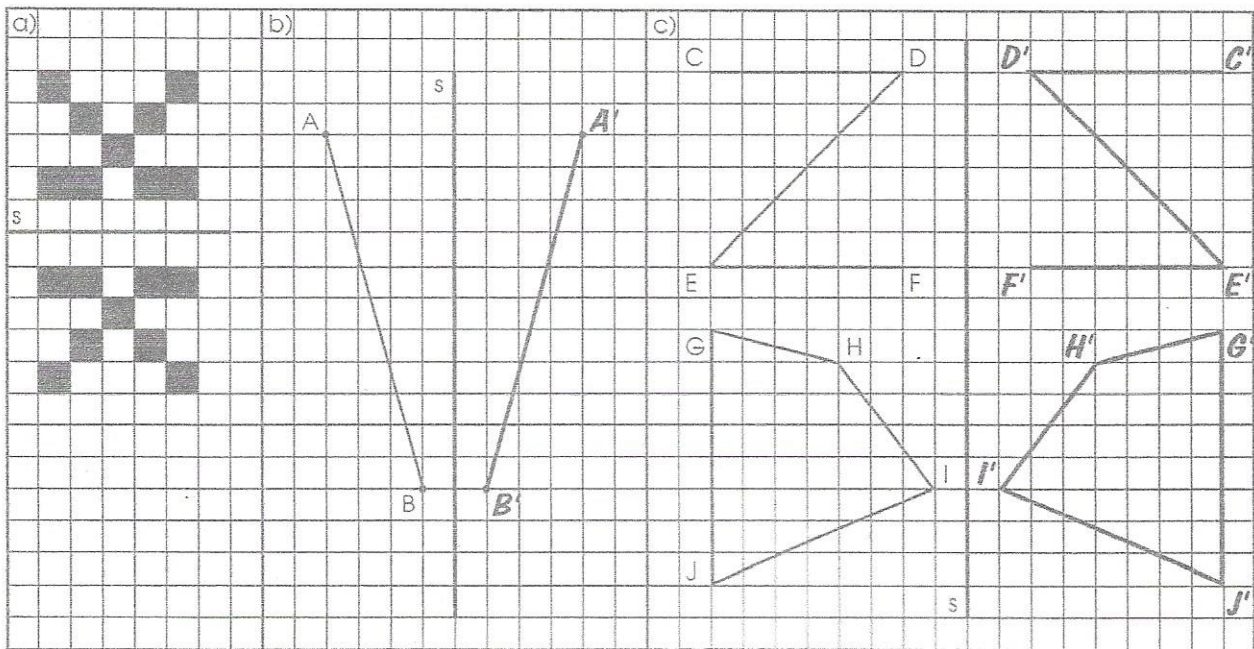

Teken de spiegelbeelden.
De rechte s is de spiegelglas.

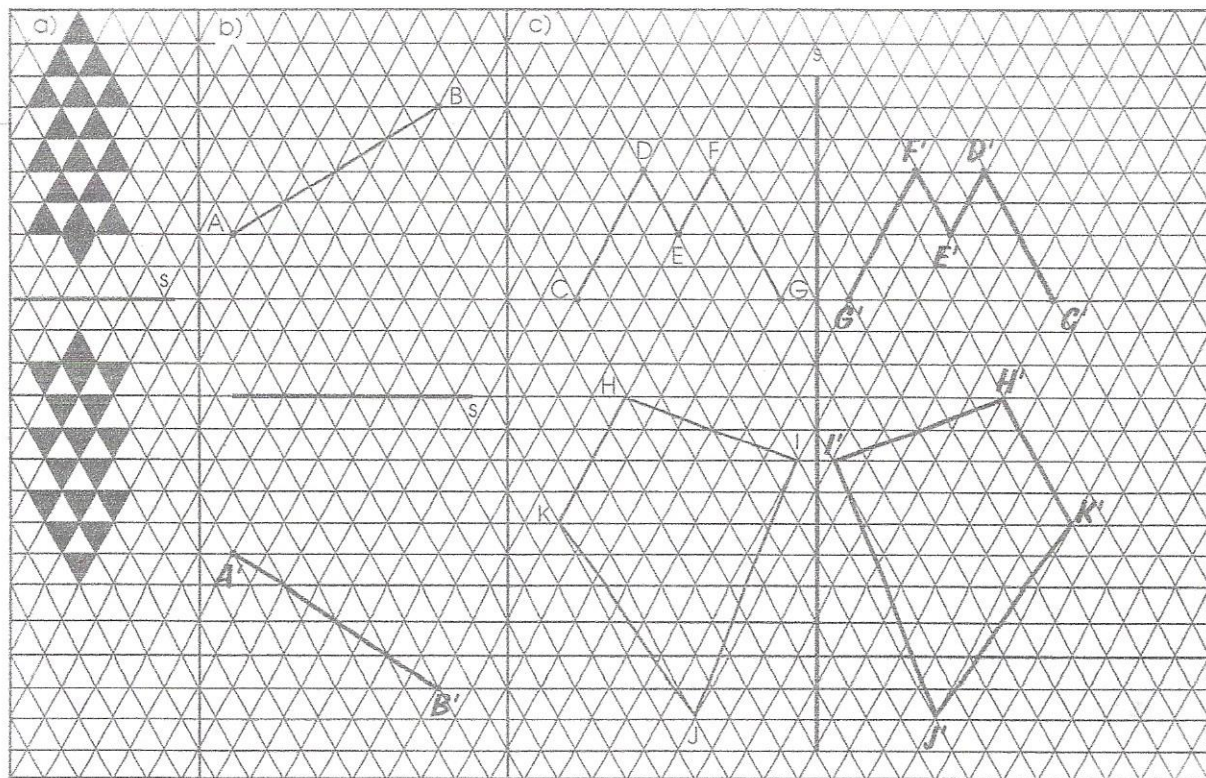



Teken de spiegelbeelden.
De rechte s is de spiegelglas.

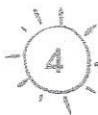
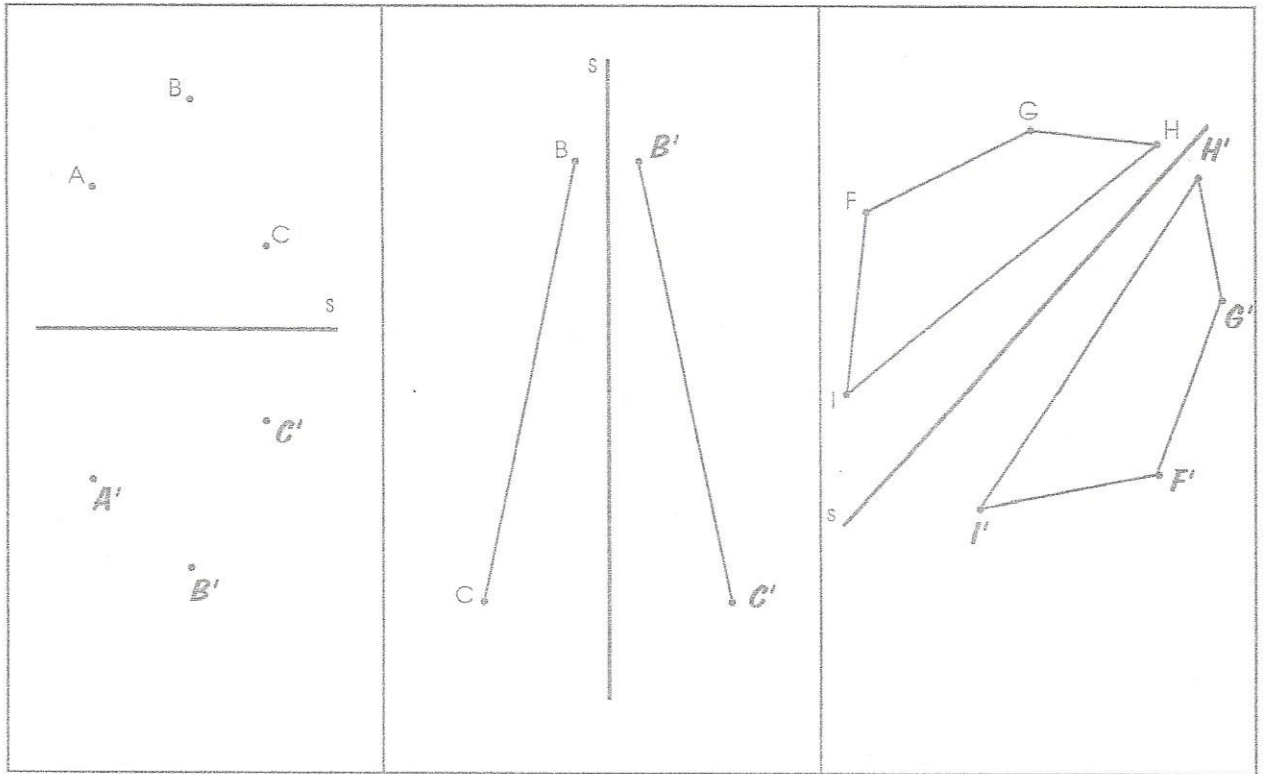

De rechte s is de spiegelglas.
Het spiegelbeeld is de tekening aan de rechterkant of aan de onderkant van de spiegelglas.
Teken een kruis over de figuren die geen spiegelbeeld zijn.

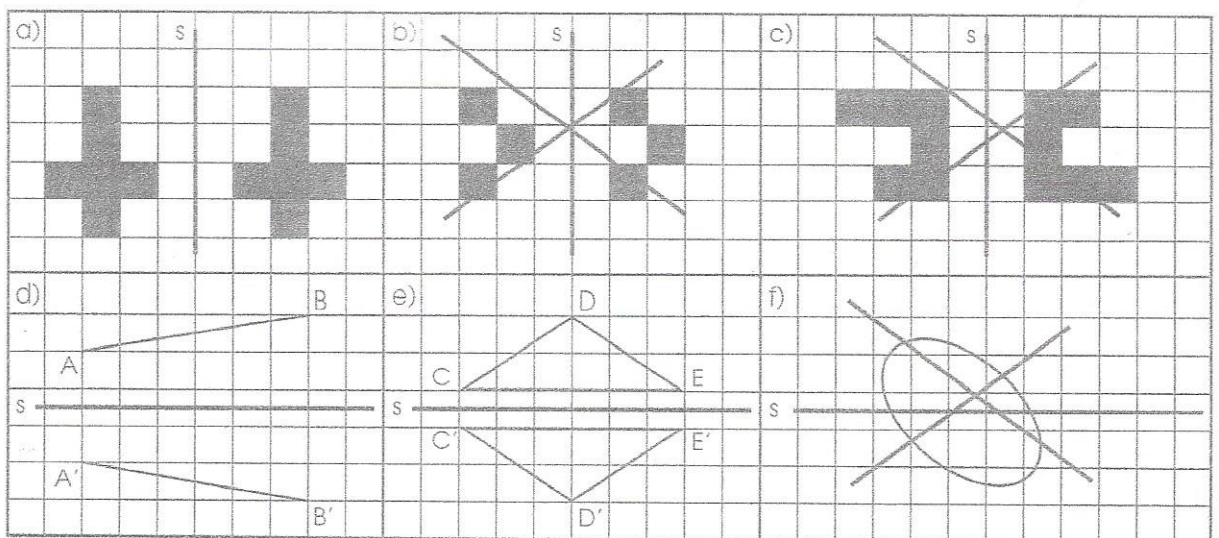

5

Aan de waterkant. De oever is de rechte s die de spiegelglas is.
Teken de spiegelbeelden.

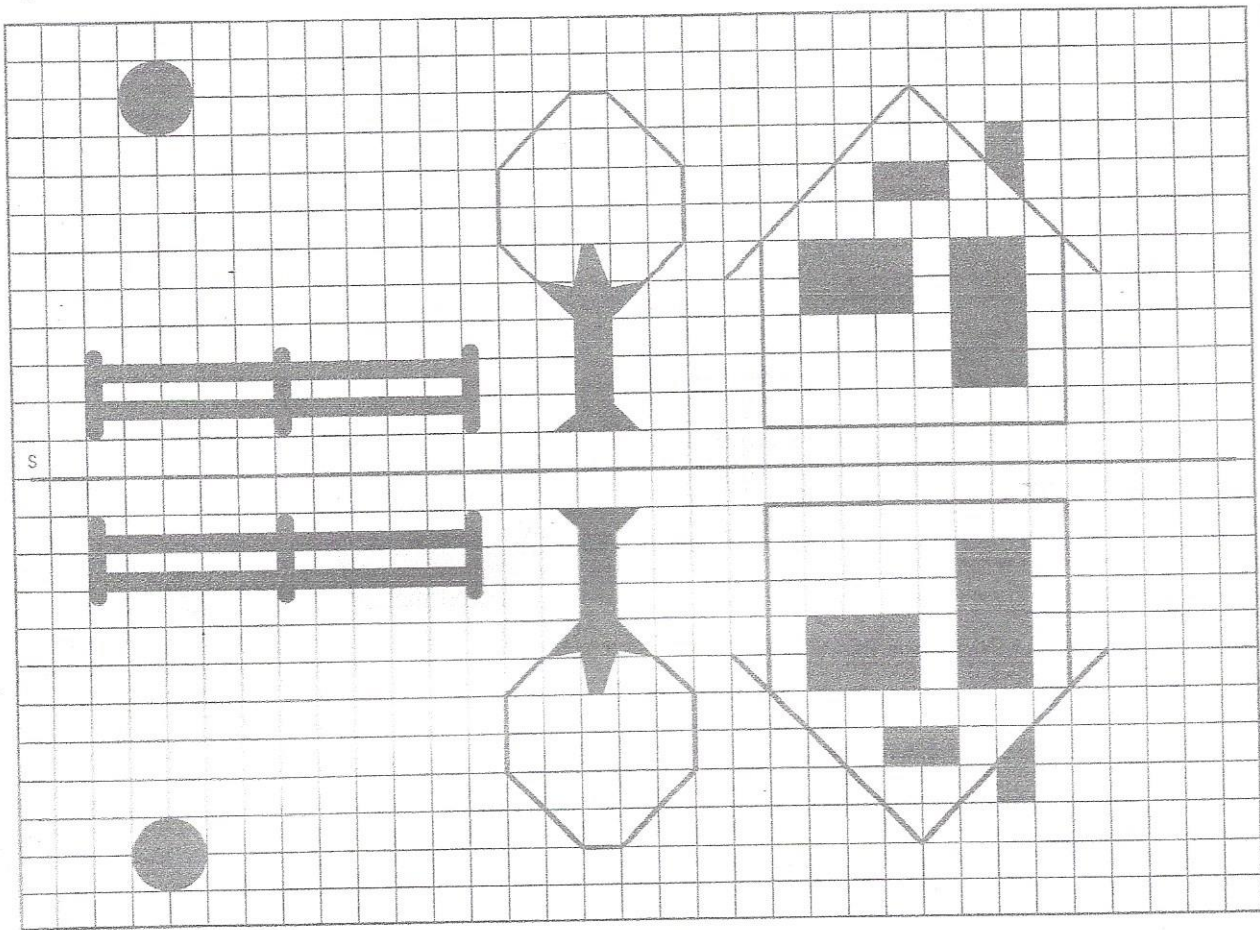

6

Teken de spiegelbeelden.
De rechte s is de spiegelglas.

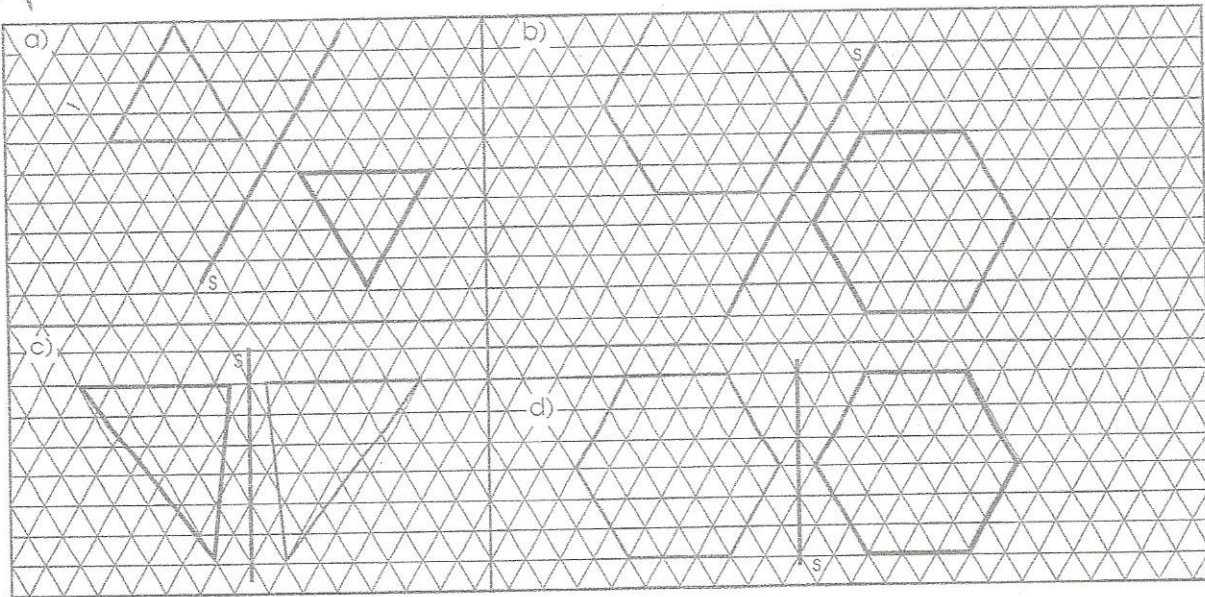

7

Teken alle mogelijke symmetrieassen.

